



Installation Guide - Hook Hung Long Column Radiators

1. Overview

This guide provides instructions for the following configurations of hook hung radiators.

1. Central Heating System and Radiator installed on Masonry Walls.







IMPORTANT NOTE: Please read the guide in full before attempting installation. It is also recommended that you read the User Manual and Warranty Document prior to installing.

IMPORTANT NOTE: We recommend the installation of this radiator is carried out by two people.

IMPORTANT NOTE: These instructions cater for Masonry Walls that are assumed to be sufficiently strong, while it may be possible to install into other wall types, the installation engineer will need to adapt the instructions and fixings to suit the location that the radiator/towel rail is being installed in.

2. Contents of Package

The contents of your package will include 1 x Radiator and the below items. Please check that these parts are included, if there is anything missing, please contact your retailer for further assistance.









Contents (included)	Description	Reference	Contents (included)	Description	Reference
	1 x Blanking Plug	A		12 x Long Screws	D
	1 x Air Vent (Bleed Valve)	B		6 x Hooks	E
	12 x Masonry Wall Plugs	C		2 x Rubber Rings	F

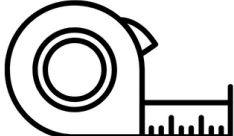

3. Tools and Parts Required

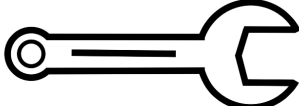
The following tools and parts may be required dependant on installation location.

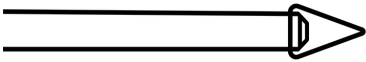
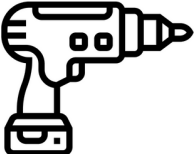
These are not included as part of the radiator package, although some may have been purchased at the same time.

Note: where images are provided for the below, they are simply visual aid examples and may not reflect exactly the part or tool you are using.

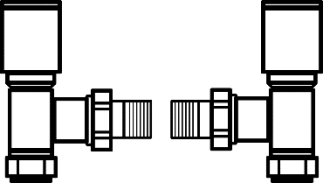
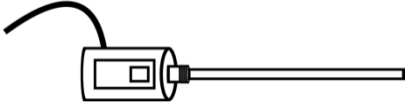
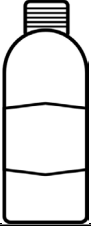
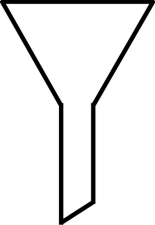
Tool / Part	Description	Installation Type
	Measuring Tape	All
	Pencil	All
	PTFE Tape	All
	Phillips Screwdriver (cross head)	All
	Flat Head Screwdriver	All
	Spanner	All
	8mm Masonry Drill Bit	All
	Tile and Glass Drill Bit	If the wall is tiled, you may need to use one of these prior to using the masonry drill bit.
	Electric Drill	All
	Spirit Level	All

	<p>Manual or Thermostatic Valves</p>	<p>All</p>
	<p>Electric Element</p>	<p>Electric Only Installations</p>
	<p>Electric Only Fluid</p>	<p>Electric Only Installations</p>
	<p>Funnel</p>	<p>Electric Only Installations</p>
	<p>Additional Blanking Plug</p>	<p>Electric Only Installations</p>
	<p>Clean Cloth</p>	<p>All</p>

4. Locating the Flow Blocker

These radiators have a flow blocker to help the water circulate around the radiator. The side with the flow diverter is usually marked with a small sticker, however, in the instance that this is not on the radiator, look into the connection points (a light source may be needed).

When the radiator is mounted, the block should be on the hot water flow side of the radiator.

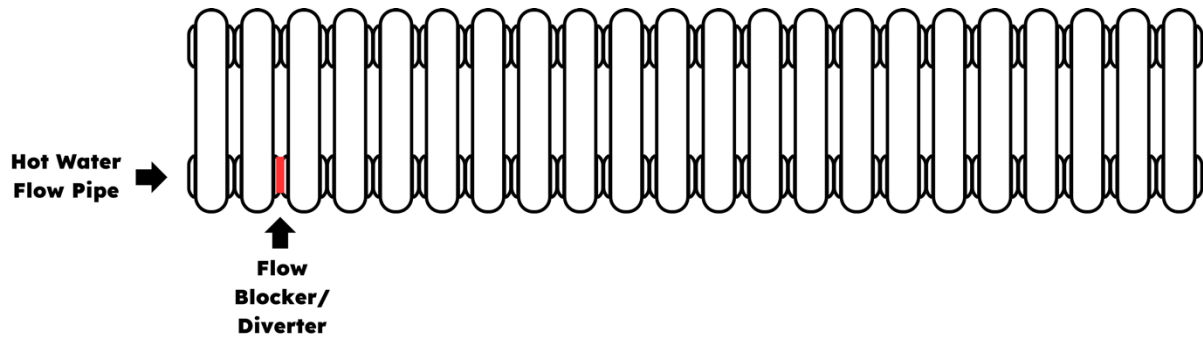

5. Central Heating Installation

Remove any end caps from the top and bottom of the radiator.

Step 1

Attach rubber rings (F) (if not already applied) and apply PTFE tape to blanking plug (A) and air vent (B). Insert into top 2 threads of radiator, cover with a cloth to prevent damage to the radiator and tighten with spanner.

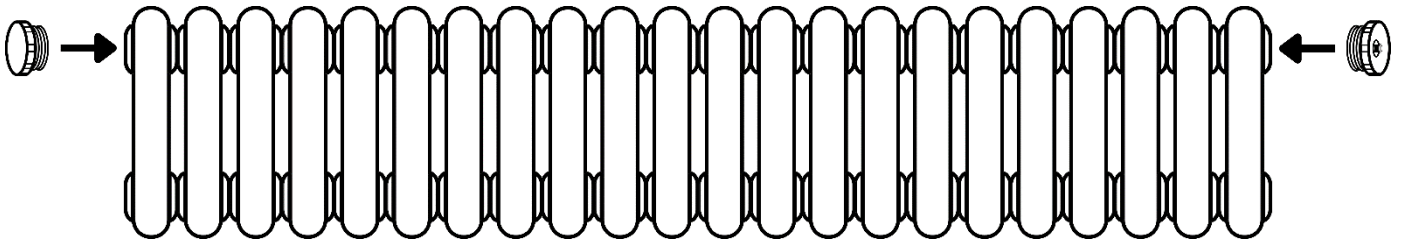

Step 2

(Check Valve Instructions) - If appropriate, apply PTFE tape to valve tails and insert into bottom 2 threads of the radiator and tighten with a spanner.

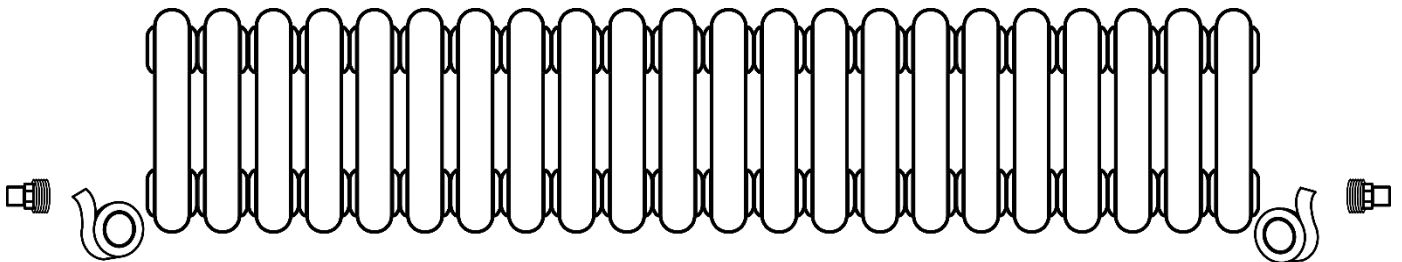

Step 3

In your desired location, mark the 2 drill points for each of the 6 hooks (E) using a pencil. These should install at least 1 column from either end and the centre column, the brackets go around the column.

Ensure your markings are level using a spirit level before proceeding.

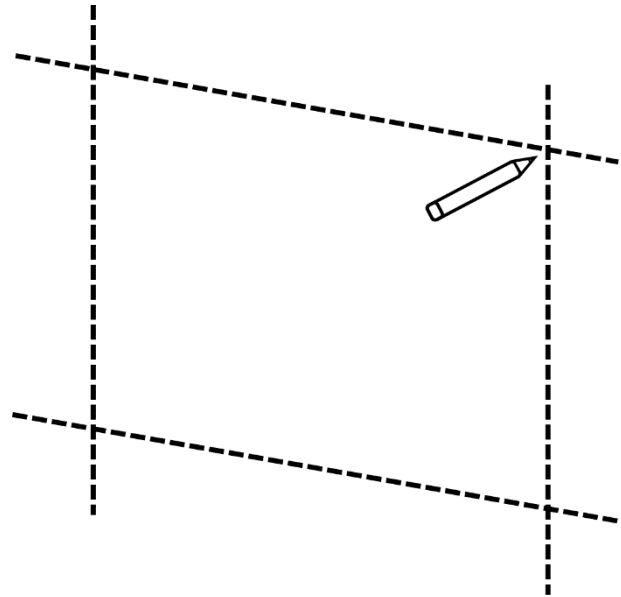

Step 4

Using the drill and 8mm masonry drill bit, drill a hole in the 2 marked locations for each hook (E).

(Note: on tiled walls you may need to use a tile drill bit prior to masonry).

Insert the 2 wall plugs (C) for each hook.

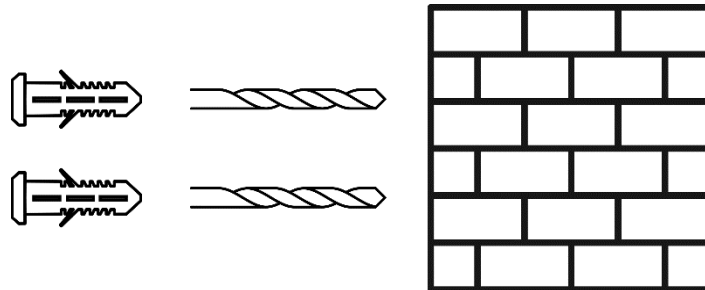

Insert the 2 screws (D) for each hook. Fully tighten the 2 screws for the top 3 hooks, and partially tighten the 2 screws for the bottom 3 hooks.

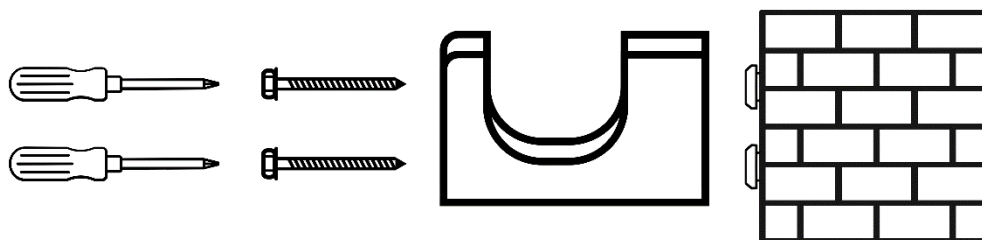

Step 5

Hang the radiator on the top 3 hooks.

Adjust the bottom 3 hooks and fully tighten the 2 screws with a spanner.

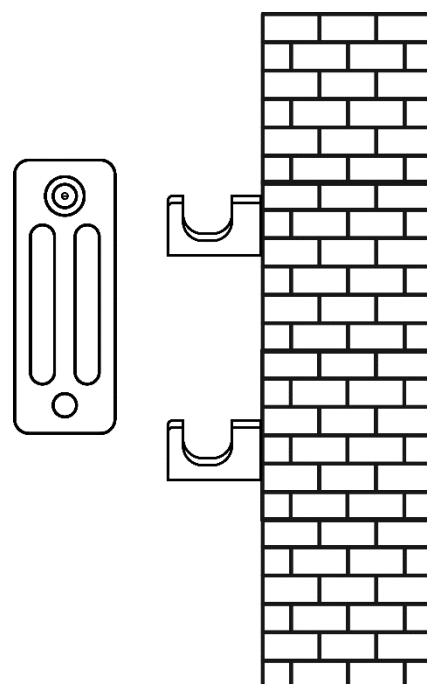

Step 6

You are now ready to run, adjust and connect your piping and valve to the radiator valve tail inserted into the radiator during step 2.

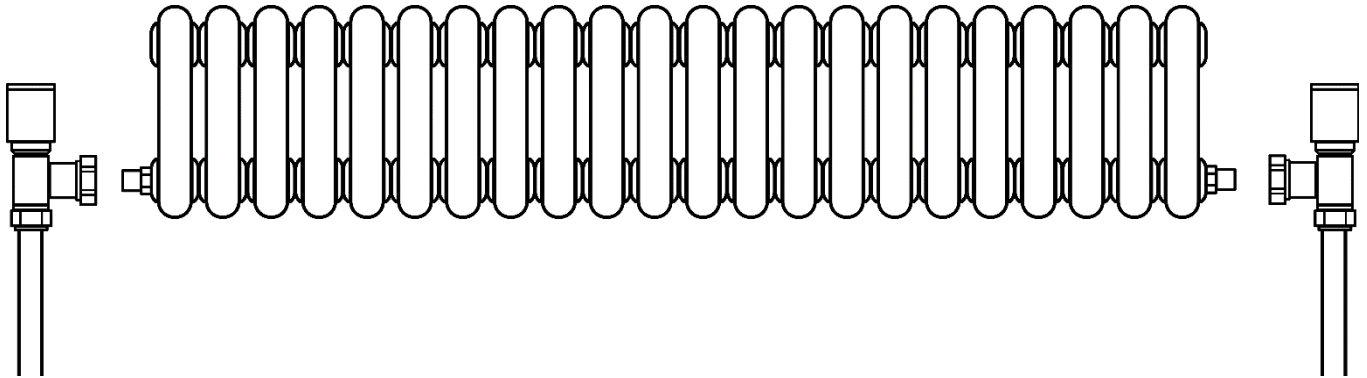

Step 7

Prior to operating the radiator, you may need to flush the system to clear any residue.

Step 8

Prior to operating the radiator, please review the User Manual.

Step 9

When the heating system is turned on for the first time, you may need to bleed the radiator using the air vent installed on the top thread per step 1. You may need to do this several times and if on a pressurised system, you may need to top up the pressure each time the radiator is bled.

Step 10

You may also need to balance the central heating system to account for this radiator.

Step 11

If there are any issues with the radiator, please first consult the User Manual including the troubleshooting section.

6. Electric Only Installation

IMPORTANT NOTE: To ensure the radiator is heated correctly by the INOW+ element, the element must be in Ambient heating mode. Home Broadband with WiFi and Android or iOS smart phone or tablet are required to access the ambient heating functions.

Remove any end caps from the top and bottom of the radiator.

Step 1

To convert this radiator to electric, we need to first remove the flow diverter.

Using a rubber mallet and steel rod, hit the flow diverter until it opens (per other image below).

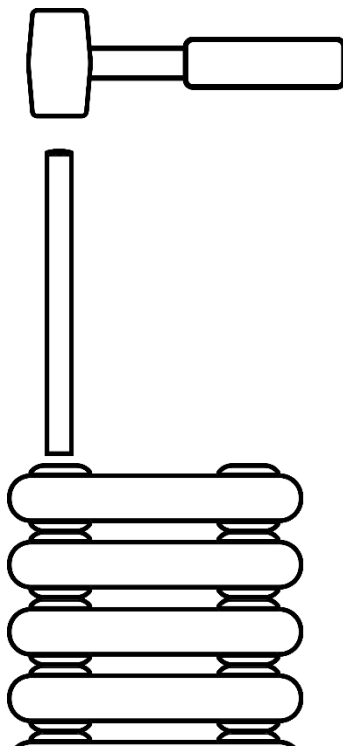

The left image below is the flow diverter as designed.

The image on the right is after removing the centre block piece.

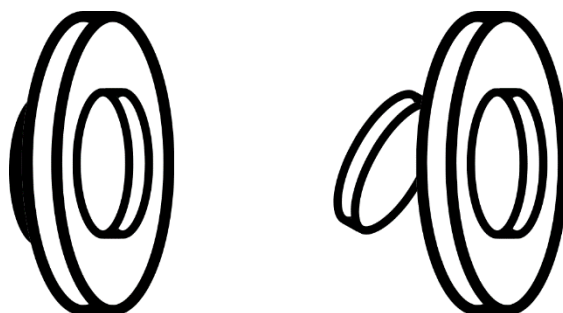

Step 2

Attach rubber rings (K) (if not already applied) and apply PTFE tape to blanking plug (A) and air vent (B). Insert into top 2 threads of radiator, cover with a cloth to prevent damage to the radiator and tighten with spanner.

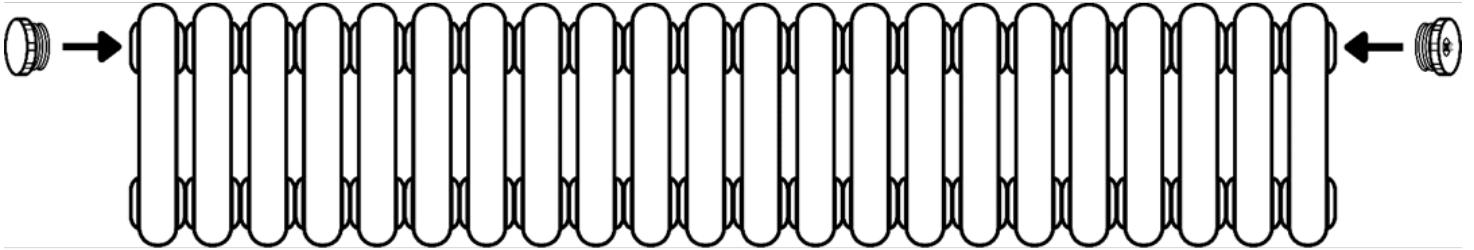

Step 3

(Check element instructions) - Using PTFE tape, insert the element per the element instructions on the other side of the radiator.

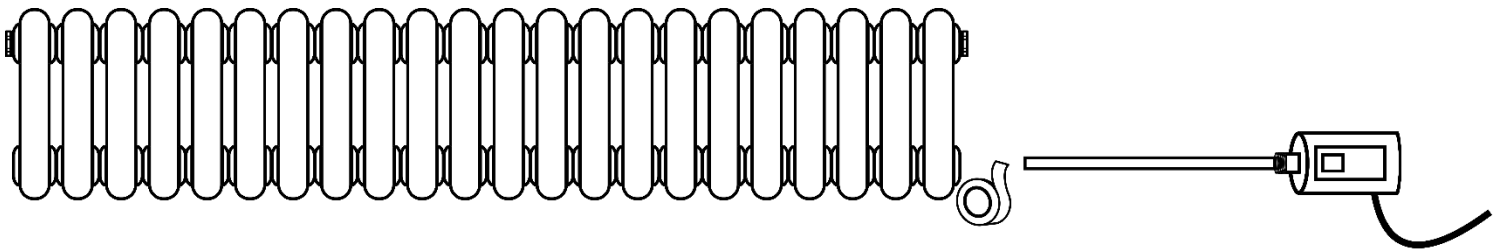

Step 4

In your desired location, mark the 2 drill points for each of the 4 hooks (E) using a pencil. These should install at least 1 column from either end, the brackets go around the column.

Ensure your markings are level using a spirit level before proceeding.

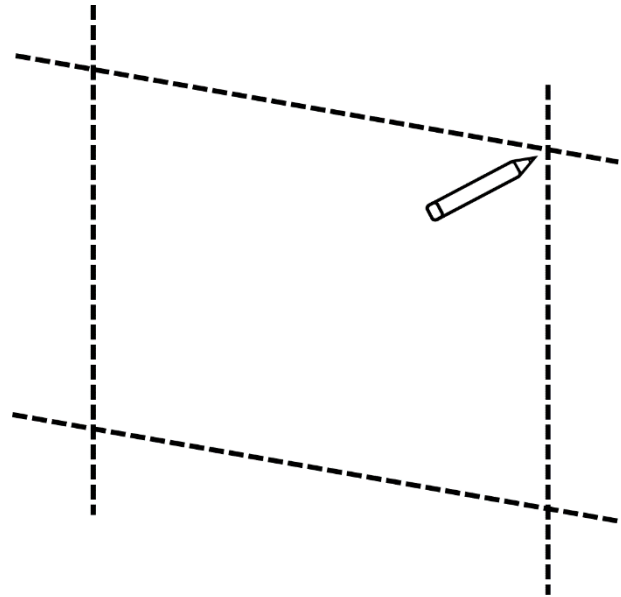
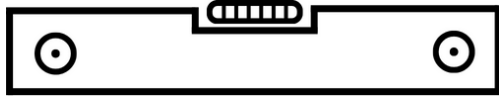

Step 5

Using the drill and 8mm masonry drill bit, drill a hole in the 2 marked locations for each hook (E).

(Note: on tiled walls you may need to use a tile drill bit prior to masonry).

Insert the 2 wall plugs (C) for each hook.

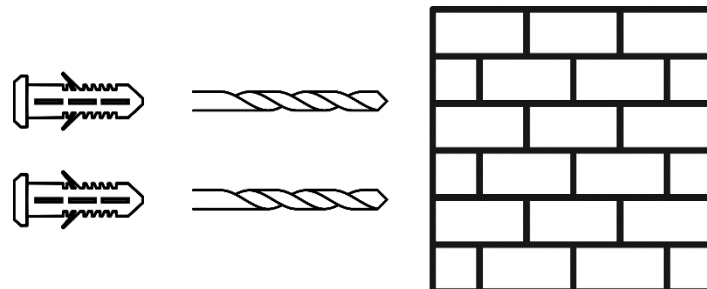

Insert the 2 screws (D) for each hook. Fully tighten the 2 screws for the top 2 hooks, and partially tighten the 2 screws for the bottom 2 hooks.

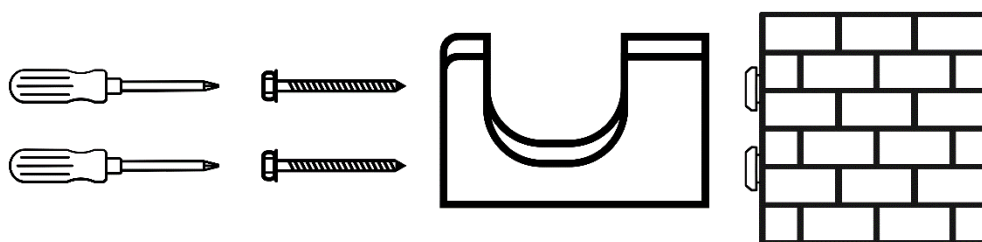

Step 6

WARNING: Do not balance the radiator on the heating element. Do not overfill or underfill, follow the instructions carefully.

Standing on the blanking plug side, insert the funnel into the open end of the radiator, pour in the heating solution and fill the rest of the way with water to the red line below.

Attach blanking plug (A) to thread (refer to step 1 if unsure how to do this).

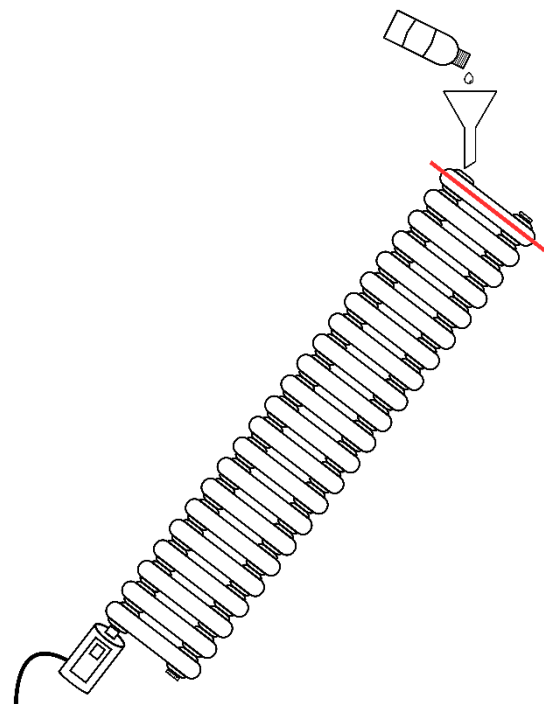

Step 7

Hang the radiator on the top 2 hooks.

Adjust the bottom 2 hooks and fully tighten the 2 screws with a spanner.

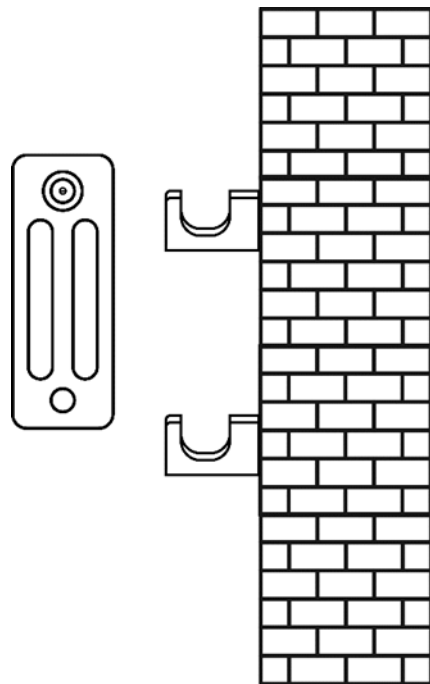

Step 8

You are now ready to connect the heating element to the electrical supply.

WARNING: The installation of any electric element and connection to electricity supply must be carried out by a registered competent electrician. Please refer to the element installation guide for further instructions.

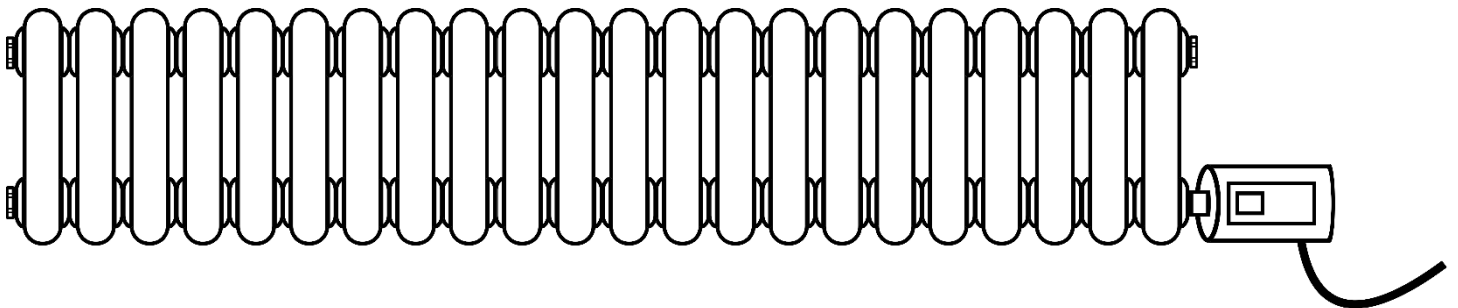

Step 9

Prior to operating the radiator, please review the User Manual for both the radiator and the electric element in place and ensure the element is set to Ambient Mode through the app.

Step 10

If there are any issues with the radiator, please first consult the User Manual including the troubleshooting section. For any issues with the electric element, please consult the User Manual for that product.

Step 11

There may be further steps to complete the installation of the electric element, such as WiFi connection or time of day configuration, please refer to the electric element user guide for how to do this.