



**UKRadiators.com**



## Installation Guide – Designer Towel Rails

# 1. Overview

This guide provides instructions for the following configurations:

1. Central Heating System installed on Masonry Walls.
2. Dual Fuel installed on Masonry Walls
3. Electric Only installed on Masonry Walls









**IMPORTANT NOTE:** Please read the guide in full before attempting installation. It is also recommended that you read the User Manual and Warranty Document prior to installing.

**IMPORTANT NOTE:** These instructions cater for Masonry Walls that are assumed to be sufficiently strong, while it may be possible to install into other wall types, the installation engineer will need to adapt the instructions and fixings to suit the location that the radiator/towel rail is being installed in.

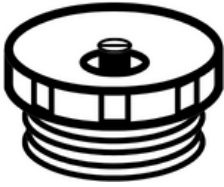
**WARNING:** The installation of any electric element must be carried out by a registered competent electrician.

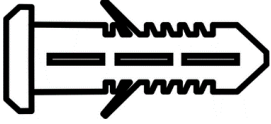
## 2. Contents of Package

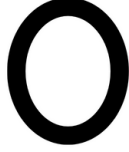
The contents of your package will include 1 x Radiator and the below items. Please check that these parts are included, if there is anything missing, please contact your retailer for further assistance.









Contents (included)	Description	Reference	Contents (included)	Description	Reference
	1 x Blanking Plug	A		4 x Brackets	F
	1 x Air Vent (Bleed Valve)	B		4 x Small Screws	G
	4 x Masonry Wall Plugs	C		4 x Cross Bolts	H
	4 x Long Screws	D		2 x Rubber Rings	I
	4 x Wall support	E			

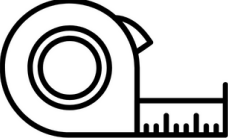

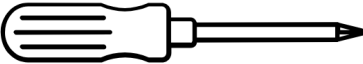
### 3. Tools and Parts Required

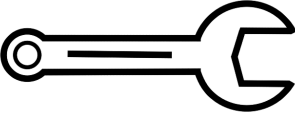
The following tools and parts may be required dependant on installation location.

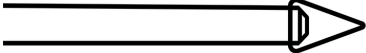
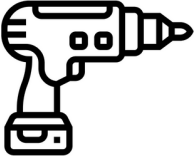
These are not included as part of the radiator/towel rail package, although some may have been purchased at the same time or as a bundle with the radiator/towel rail packaged separately.

Note: where images are provided for the below, they are simply visual aid examples and may not reflect exactly the part or tool you are using.

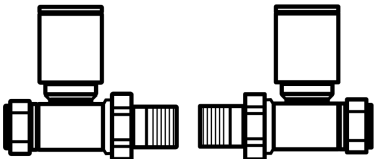
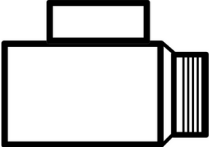
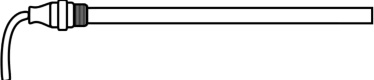
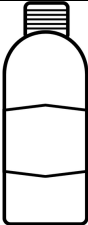
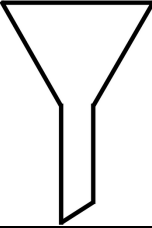
Tool / Part	Description	Installation Type
	Measuring Tape	All
	Pencil	All
	PTFE Tape	All
	Philips Screwdriver (cross head)	All
	Flat Head Screwdriver	All
	Spanner	All
	8mm Masonry Drill Bit	All
	Tile and Glass Drill Bit	If the wall is tiled, you may need to use one of these prior to using the masonry drill bit.
	Electric Drill	All
	Spirit Level	All

	<p>Manual or Thermostatic Valves</p>	<p>Central Heating and Dual Fuel Installations</p>
	<p>T-Piece</p>	<p>Dual Fuel Installations</p>
	<p>Electric Element</p>	<p>Dual Fuel and Electric Only Installations</p>
	<p>Electric Only Fluid</p>	<p>Electric Only Installations</p>
	<p>Funnel</p>	<p>Electric Only Installations</p>
	<p>Additional Blanking Plug</p>	<p>Electric Only Installations</p>
	<p>Clean Cloth</p>	<p>All</p>

## 4. Central Heating Installation

Remove any end caps from the top and bottom of the radiator.

### Step 1

Attach rubber rings (I) (if not already applied) and apply PTFE tape to blanking plug (A) and air vent (B). Insert into top 2 threads of radiator, cover with a cloth to prevent damage to the radiator and tighten with spanner.

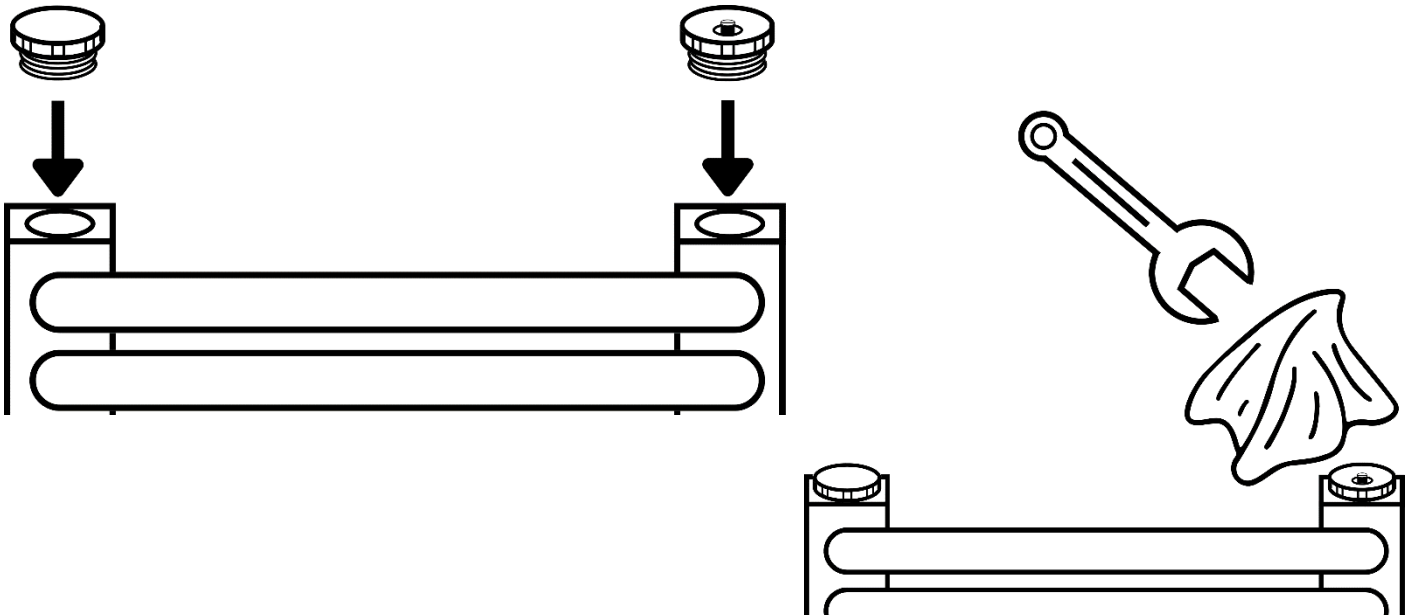

### Step 2

(Check Valve Instructions) – If appropriate, apply PTFE tape to valve tails and insert into bottom 2 threads of the radiator and tighten with a spanner.

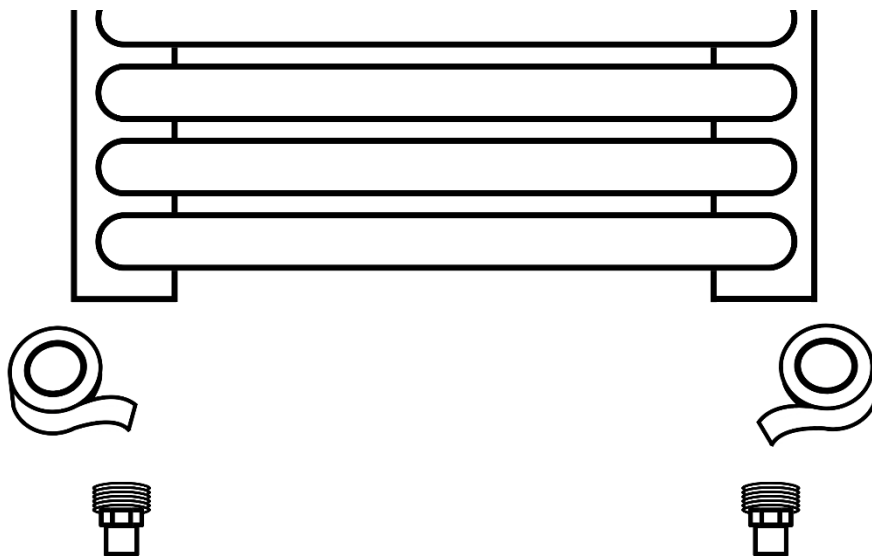

### Step 3

Put bolt (H) through bracket (F) and screw onto the back of the radiator at the pre-drilled locations.

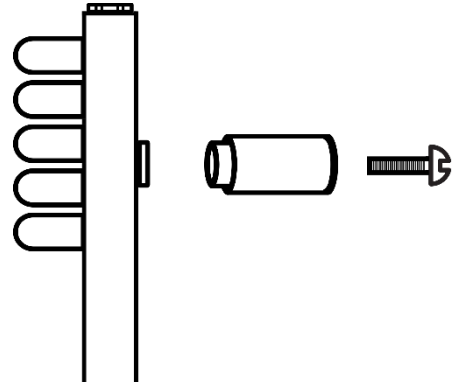

### Step 4

Mark the fixing locations with a pencil, 2 near the top of the radiator and 2 near the bottom per the locations of the bracket.

Ensure your markings are level using a spirit level before proceeding.

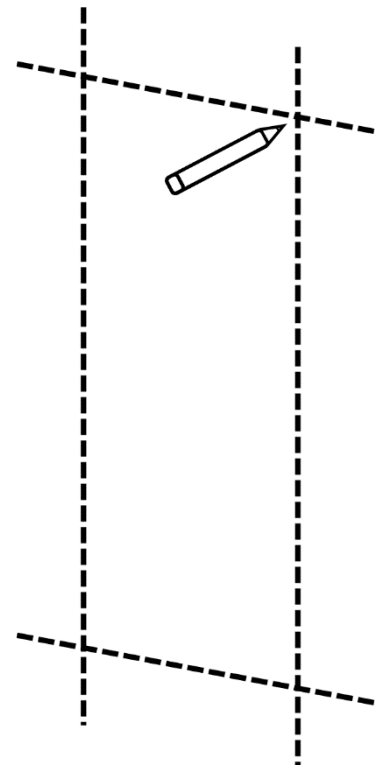
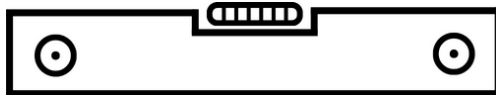

### Step 5

Using the 8mm masonry drill bit, drill holes at the marked location and insert masonry wall plugs (C).

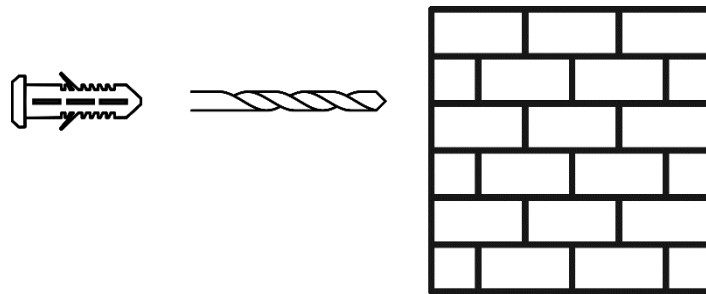

Place the long screw (D) through wall support (E) and tighten into the wall plug.

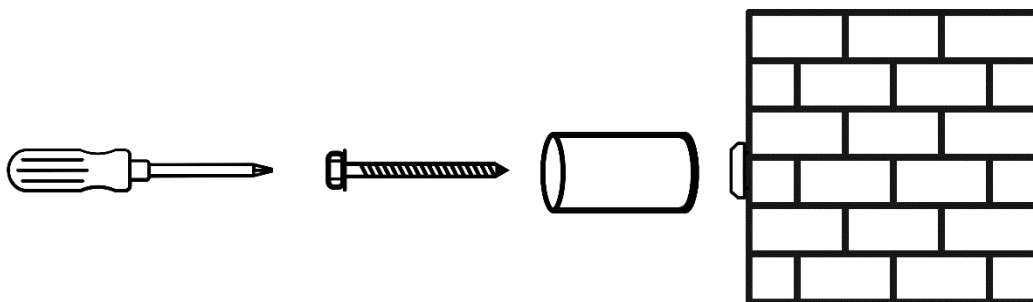

### Step 6

Slide the radiator brackets (F) into wall support (E).

Adjust depth as required, then tighten using small screws (G).

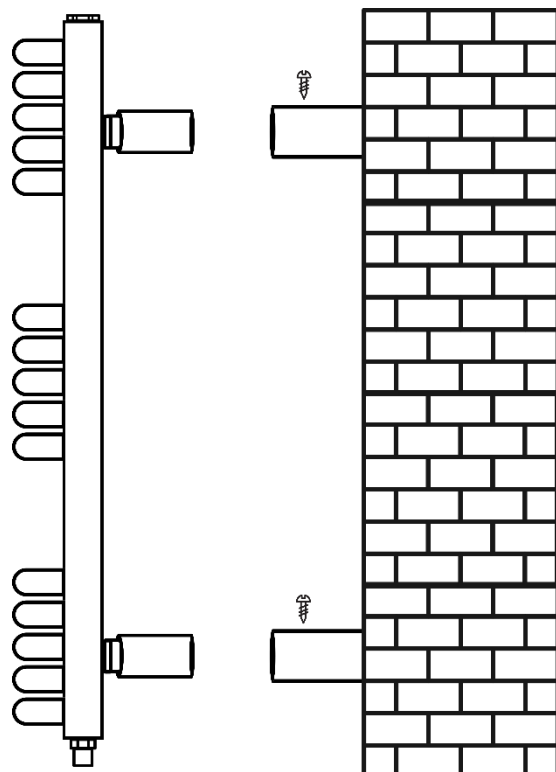



### Step 7

You are now ready to run, adjust and connect your piping and valve to the radiator valve tail inserted into the radiator during step 2.

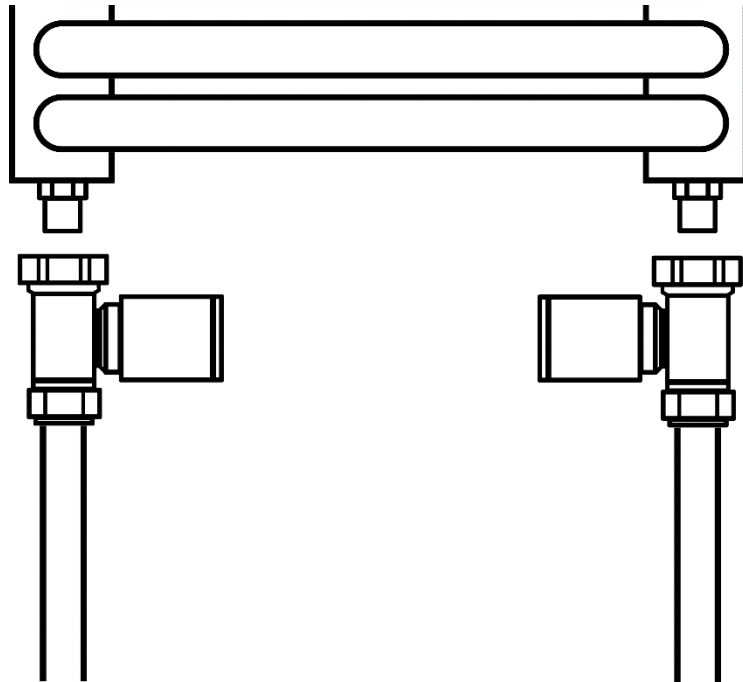

### Step 8

Prior to operating the radiator, you may need to flush the system to clear any residue.

### Step 9

Prior to operating the radiator, please review the User Manual.

### Step 10

When the heating system is turned on for the first time, you may need to bleed the radiator using the air vent installed on the top thread per step 1. You may need to do this several times and if on a pressurised system, you may need to top up the pressure each time the radiator is bled.

### Step 11

You may also need to balance the central heating system to account for this radiator.

### Step 12

If there are any issues with the radiator, please first consult the User Manual including the troubleshooting section.

## 5. Dual Fuel Heating Installation

Remove any end caps from the top and bottom of the radiator.

### Step 1

Attach rubber rings (I) (if not already applied) and apply PTFE tape to blanking plug (A) and air vent (B). Insert into top 2 threads of radiator, cover with a cloth to prevent damage to the radiator and tighten with spanner.

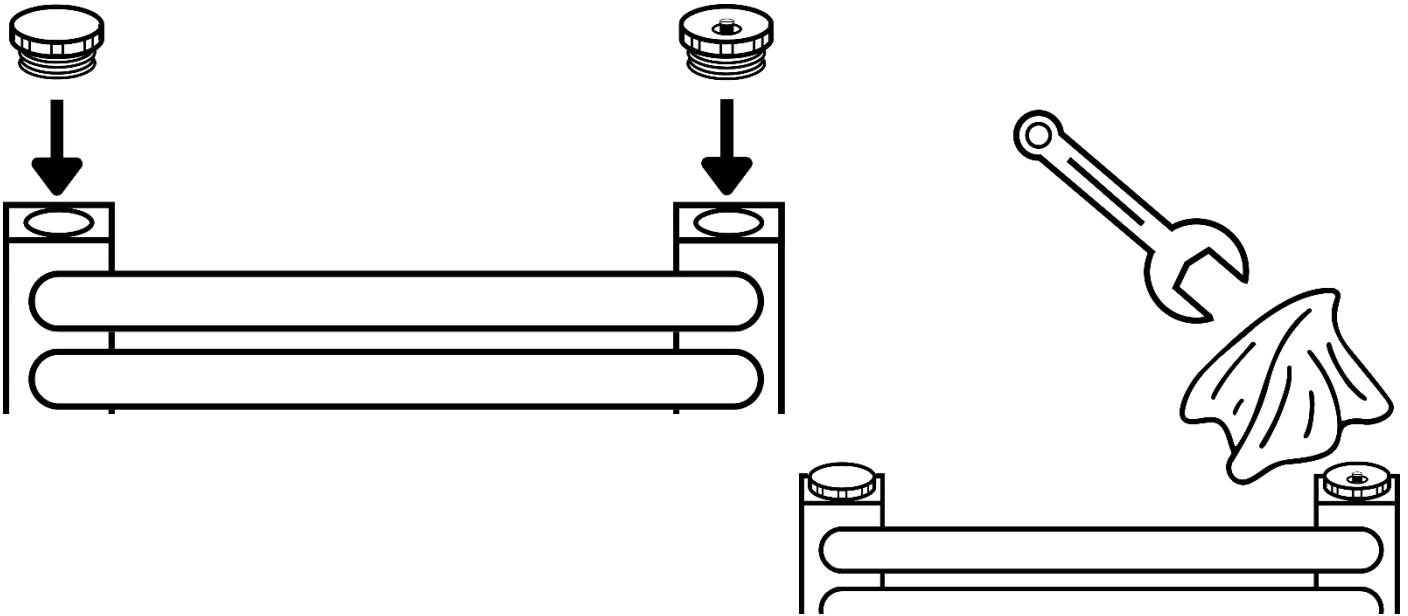

### Step 2

(Check element instructions) – If appropriate, apply PTFE tape to T-Piece and insert into one side of the bottom of the radiator and tighten with a spanner. Insert electric element per the element instructions. On the other side, if appropriate, apply PTFE tape to the valve tail, insert and tighten.

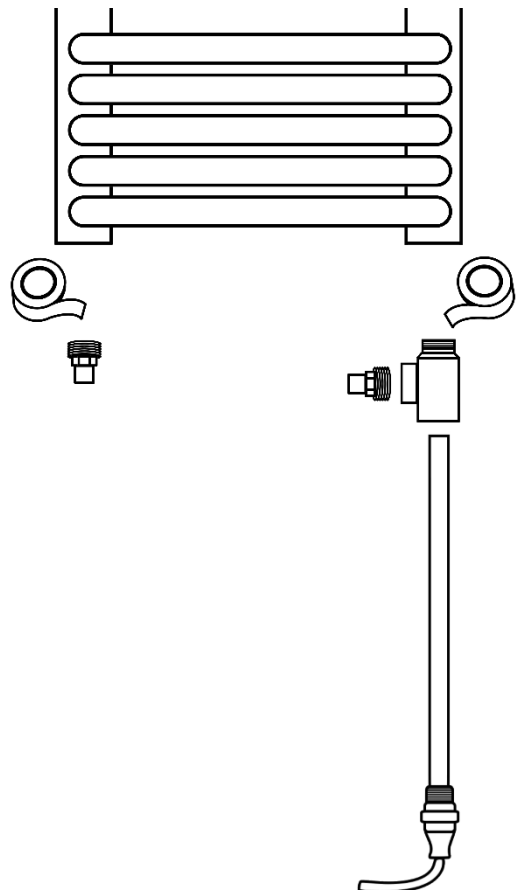

### Step 3

Put bolt (H) through bracket (F) and screw onto the back of the radiator at the pre-drilled locations.

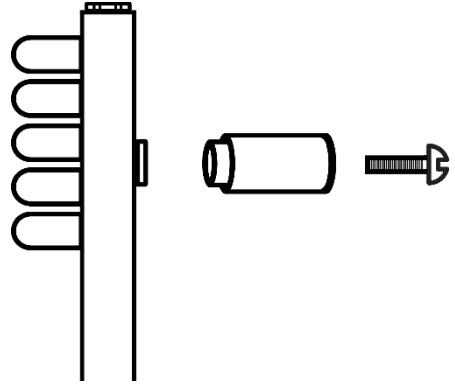

### Step 4

Mark the fixing locations with a pencil, 2 near the top of the radiator and 2 near the bottom per the locations of the bracket.

Ensure your markings are level using a spirit level before proceeding.

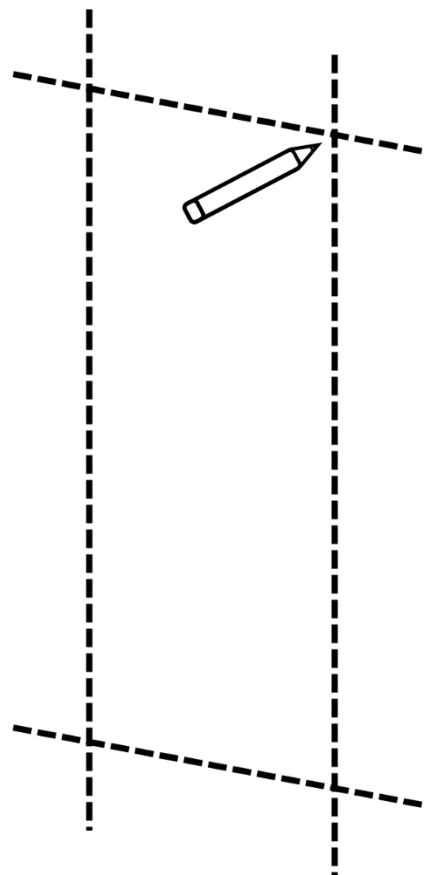

Step 5

Using the 8mm masonry drill bit, drill holes at the marked location and insert masonry wall plugs (C).

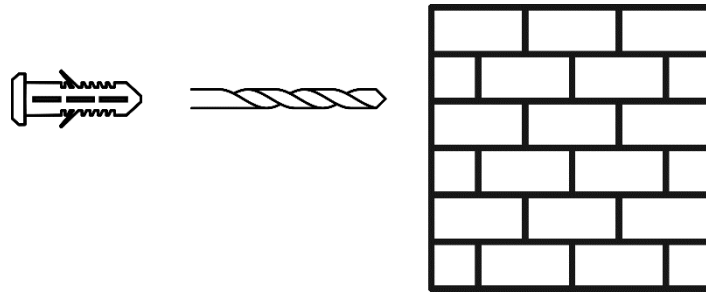

Place the long screw (D) through wall support (E) and tighten into the wall plug.

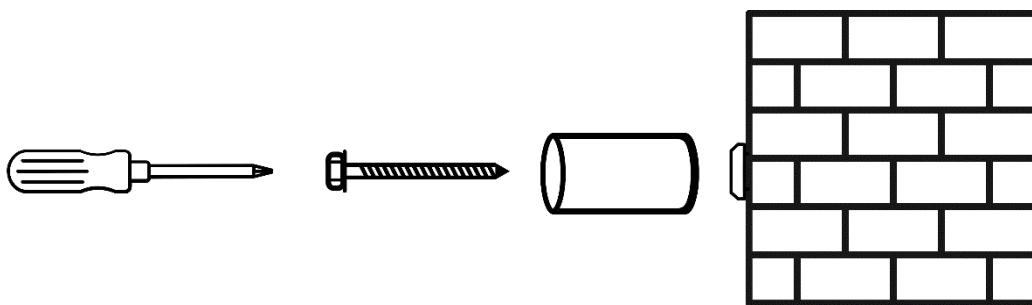

Step 6

Slide the radiator brackets (F) into wall support (E).

Adjust depth as required, then tighten using small screws (G).

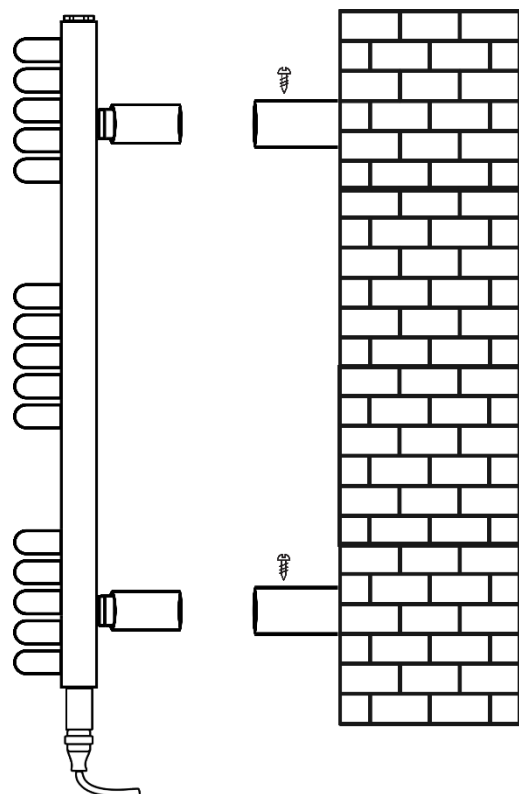

### Step 7

You are now ready to run, adjust and connect your piping and valve to the radiator valve tail and T-piece inserted into the radiator during step 2.

**WARNING:** The installation of any electric element and connection to electricity supply must be carried out by a registered competent electrician. Please refer to the element installation guide for further instructions.



### Step 8

Prior to operating the radiator, you may need to flush the system to clear any residue.

### Step 9

Prior to operating the radiator, please review the User Manual for both the radiator and the electric element in place.

### Step 10

When the heating system is turned on for the first time, you may need to bleed the radiator using the air vent installed on the top thread per step 1. You may need to do this several times and if on a pressurised system, you may need to top up the pressure each time the radiator is bled.

### Step 11

You may also need to balance the central heating system to account for this radiator.

### Step 12

If there are any issues with the radiator, please first consult the User Manual including the troubleshooting section. For any issues with the electric element, please consult the User Manual for that product.

### Step 13

There may be further steps to complete the installation of the electric element, such as WiFi connection or time of day configuration, please refer to the electric element user guide for how to do this.

## 6. Electric Only Installation

Remove any end caps from the top and bottom of the radiator.

### Step 1

Attach rubber rings (I) (if not already applied) and apply PTFE tape to blanking plug (A) and air vent (B). Insert into top 2 threads of radiator, cover with a cloth to prevent damage to the radiator and tighten with spanner.

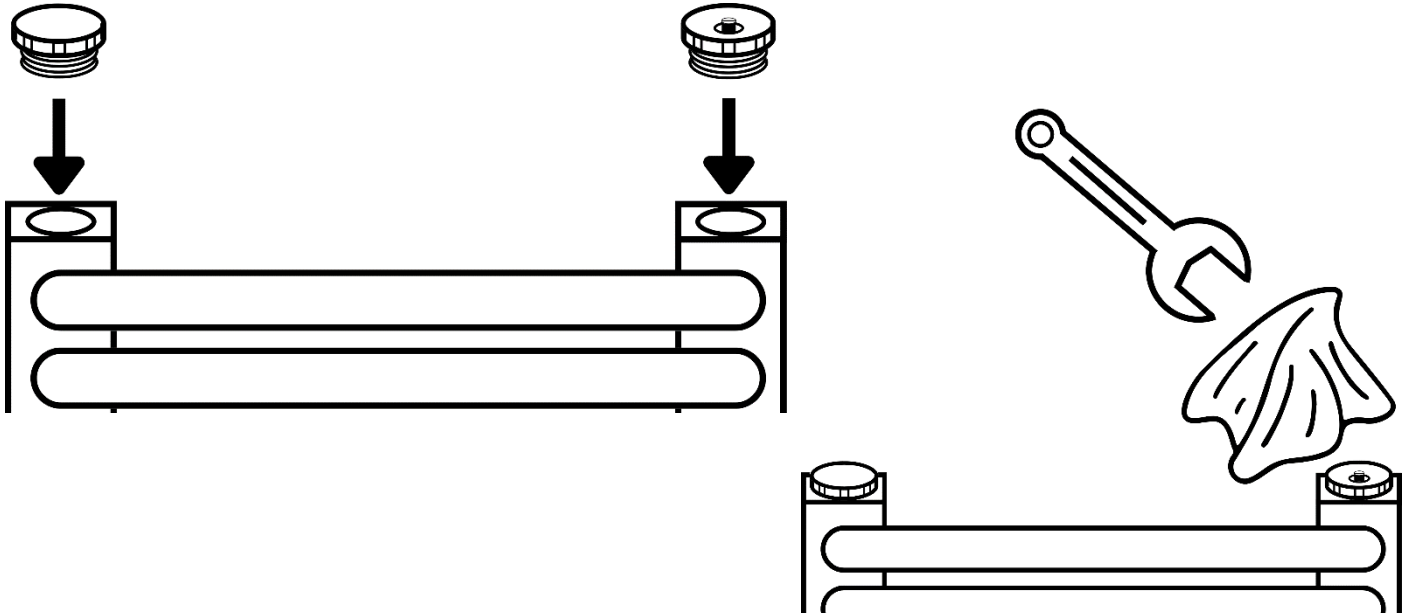

### Step 2

(Check element instructions) - Apply PTFE tape to the additional blanking plug and insert on one side of the bottom of the radiator. Insert the element per the element instructions on the other side of the radiator.

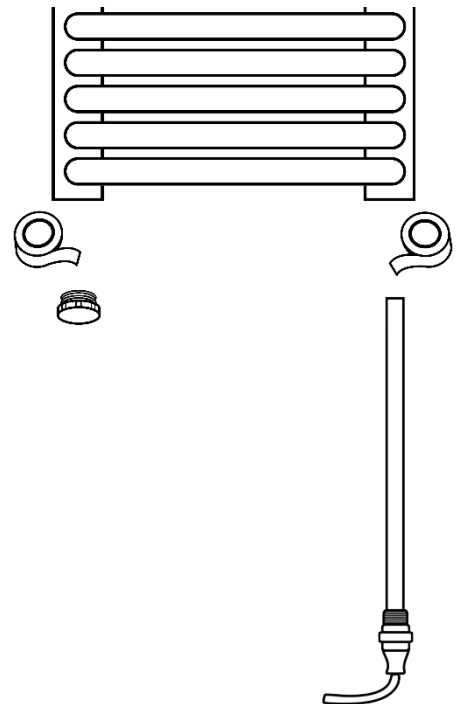

### Step 3

Put bolt (H) through bracket (F) and screw onto the back of the radiator at the pre-drilled locations.

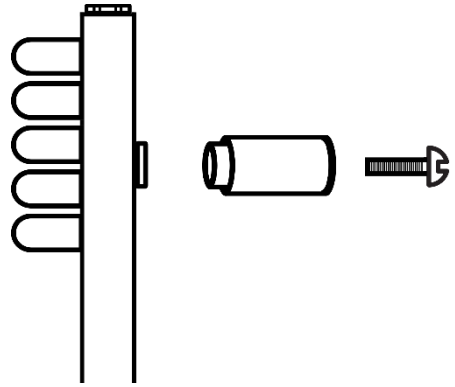

### Step 4

Mark the fixing locations with a pencil, 2 near the top of the radiator and 2 near the bottom per the locations of the bracket.

Ensure your markings are level using a spirit level before proceeding.

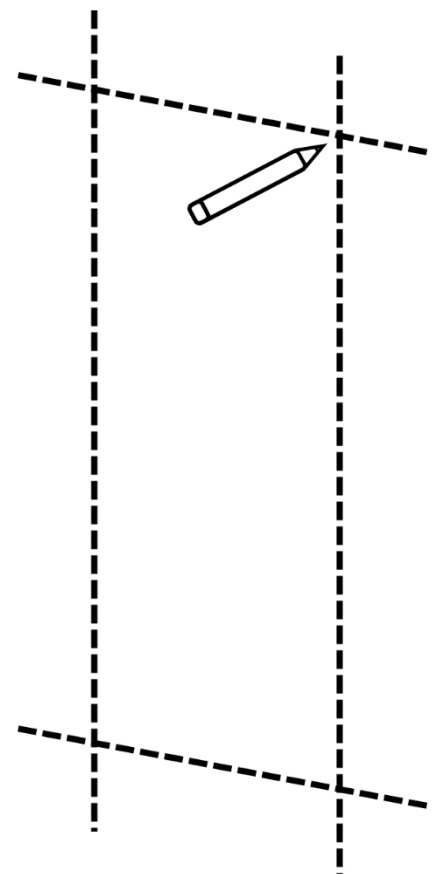

### Step 5

Using the 8mm masonry drill bit, drill holes at the marked location and insert masonry wall plugs (C).

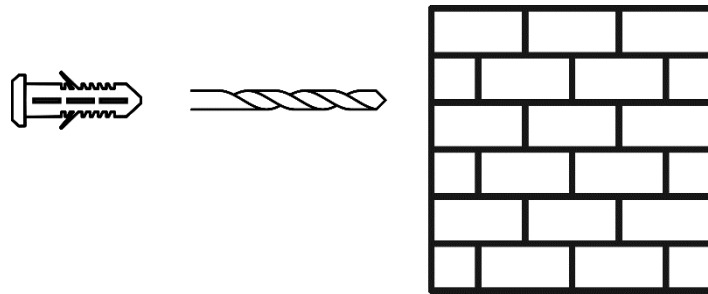

Place the long screw (D) through wall support (E) and tighten into the wall plug.

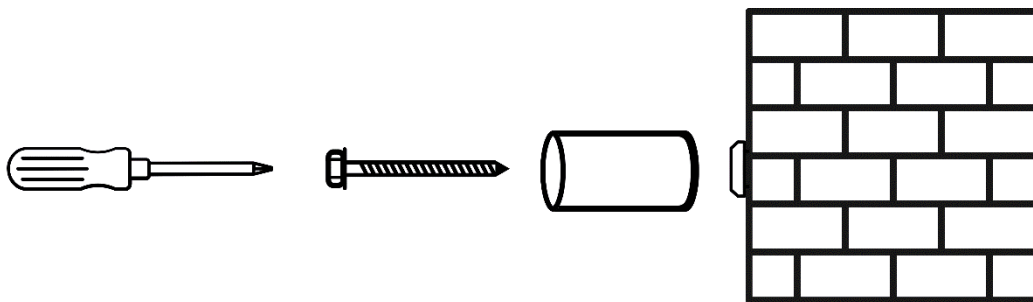

### Step 6

**WARNING: Do not balance the radiator on the heating element. Do not overfill or underfill, follow the instructions carefully.**

Standing on the blanking plug side, insert the funnel into the open top end of the radiator, pour in the heating solution and fill the rest of the way with water to the red line below.

Attach blanking plug (A) to top thread (refer to step 1 if unsure how to do this).

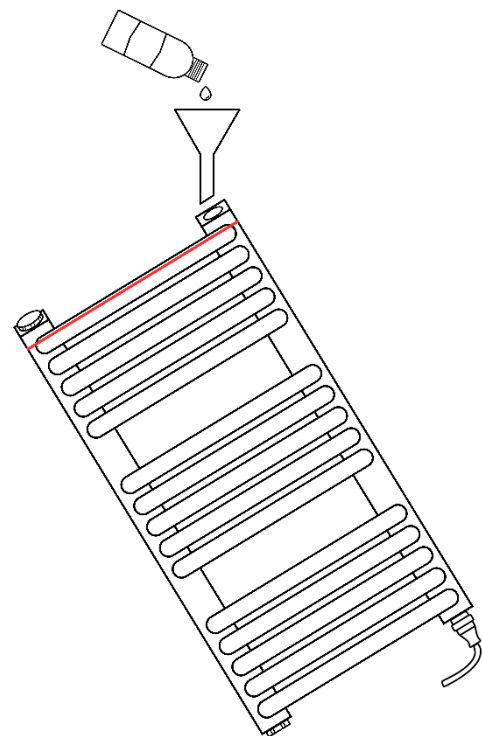



### Step 7

Slide the radiator brackets (F) into wall support

Adjust depth as required, then tighten using small screws (G).

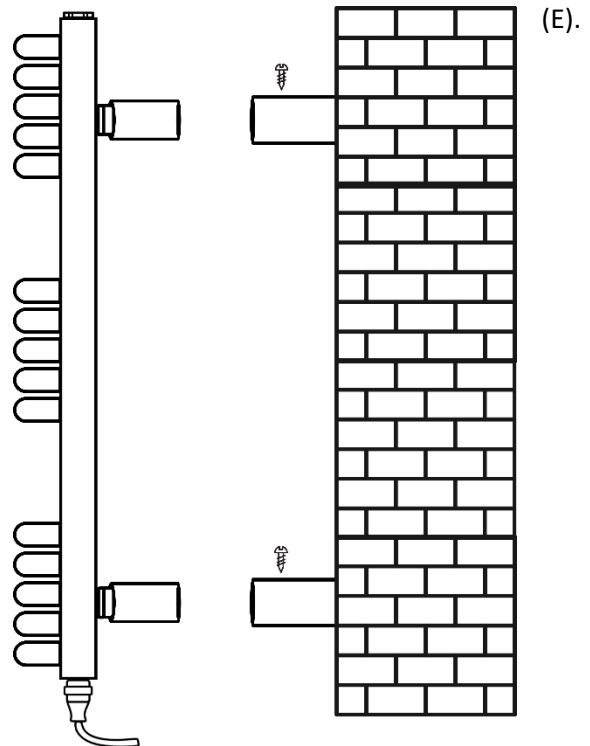

### Step 8

You are now ready to connect the heating element to the electrical supply.

**WARNING:** The installation of any electric element and connection to electricity supply must be carried out by a registered competent electrician. Please refer to the element installation guide for further instructions.

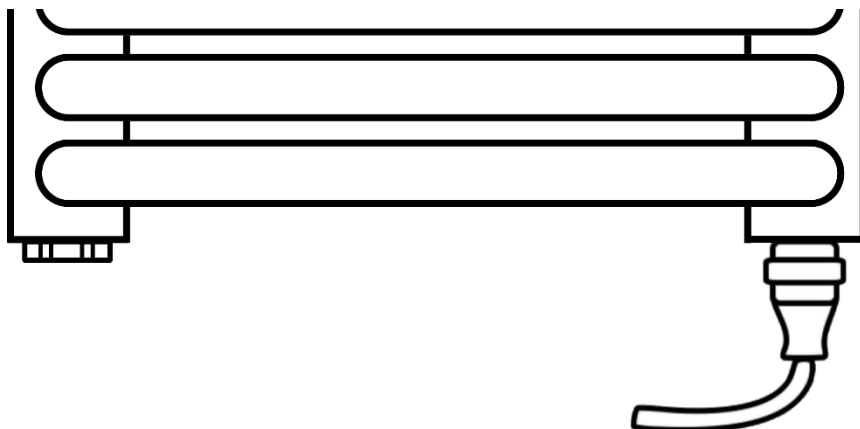

### Step 9

Prior to operating the radiator, please review the User Manual for both the radiator and the electric element in place.

#### Step 10

If there are any issues with the radiator, please first consult the User Manual including the troubleshooting section. For any issues with the electric element, please consult the User Manual for that product.

#### Step 11

There may be further steps to complete the installation of the electric element, such as WiFi connection or time of day configuration, please refer to the electric element user guide for how to do this.