

Installation Guide – Horizontal Designer Radiators

1. Overview

This guide provides instructions for the following configurations of hook hung radiators.

1. Central Heating System and Radiator installed on Masonry Walls.









IMPORTANT NOTE: Please read the guide in full before attempting installation. It is also recommended that you read the User Manual and Warranty Document prior to installing.

IMPORTANT NOTE: We recommend the installation of this radiator is carried out by two people.

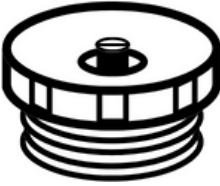
IMPORTANT NOTE: These instructions cater for Masonry Walls that are assumed to be sufficiently strong, while it may be possible to install into other wall types, the installation engineer will need to adapt the instructions and fixings to suit the location that the radiator/towel rail is being installed in.

2. Contents of Package

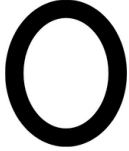
The contents of your package will include 1 x Radiator and the below items. Please check that these parts are included, if there is anything missing, please contact your retailer for further assistance.









Contents (included)	Description	Reference	Contents (included)	Description	Reference
	1 x Blanking Plug	A		4 x Brackets	F
	1 x Air Vent (Bleed Valve)	B		4 x Small Screws	G
	8 x Masonry Wall Plugs	C		4 x Cross Bolts	H
	8 x Long Screws	D		2 x Rubber Rings	I
	4 x Wall support	E			

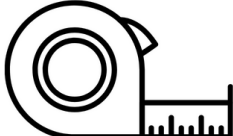

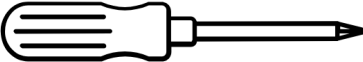
3. Tools and Parts Required

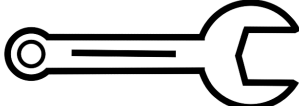
The following tools and parts may be required dependant on installation location.

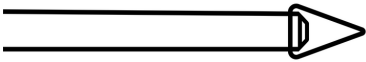
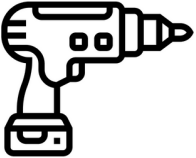
These are not included as part of the radiator package, although some may have been purchased at the same time.

Note: where images are provided for the below, they are simply visual aid examples and may not reflect exactly the part or tool you are using.

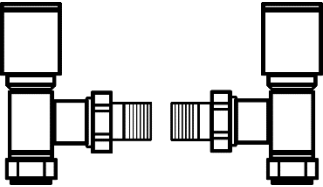
Tool / Part	Description	Installation Type
	Measuring Tape	All
	Pencil	All
	PTFE Tape	All
	Phillips Screwdriver (cross head)	All
	Flat Head Screwdriver	All
	Spanner	All
	8mm Masonry Drill Bit	All
	Tile and Glass Drill Bit	If the wall is tiled, you may need to use one of these prior to using the masonry drill bit.
	Electric Drill	All
	Spirit Level	All

	<p>Manual or Thermostatic Valves</p>	<p>All</p>
	<p>Clean Cloth</p>	<p>All</p>

4. Convert to Horizontal

When installing to horizontal the flow diverter will need to be taken out.

If you want the tubes to run horizontally along your wall (like the image below) then follow this guide, otherwise please use the “Vertical Tube” guide.

Step 1

Using a rubber mallet and steel rod, hit the flow diverter until it opens (per other image below).

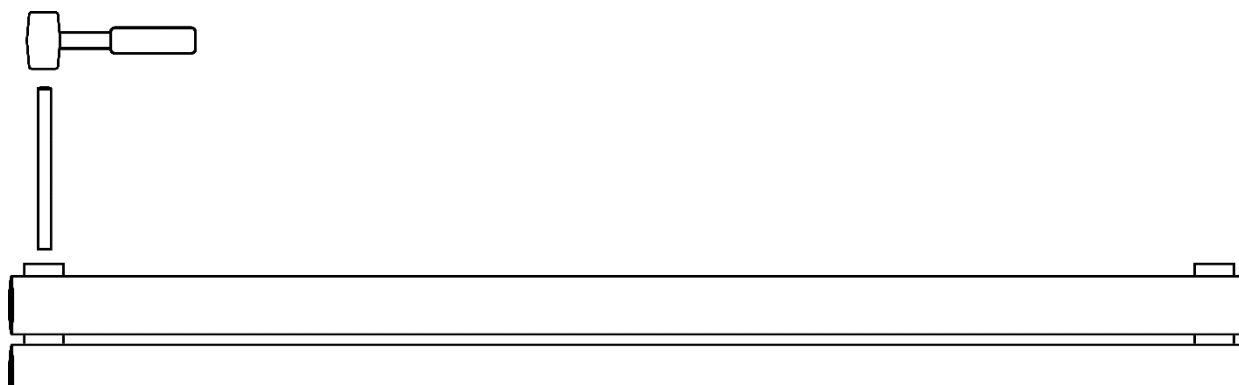

The left image below is the flow diverter as designed.

The image on the right is after removing the centre block piece.

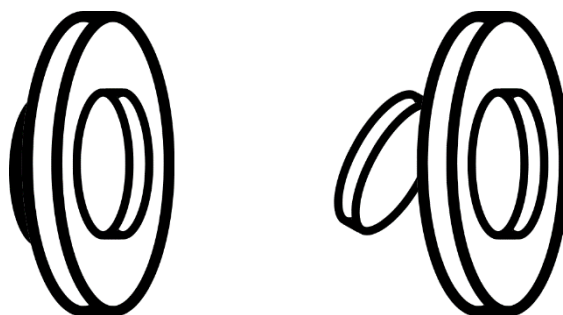

5. Central Heating Installation

Remove any end caps from the top and bottom of the radiator.

Step 1

Attach rubber rings (I) (if not already applied) and apply PTFE tape to blanking plug (A) and air vent (B). Insert into top 2 threads of radiator, cover with a cloth to prevent damage to the radiator and tighten with Spanner.

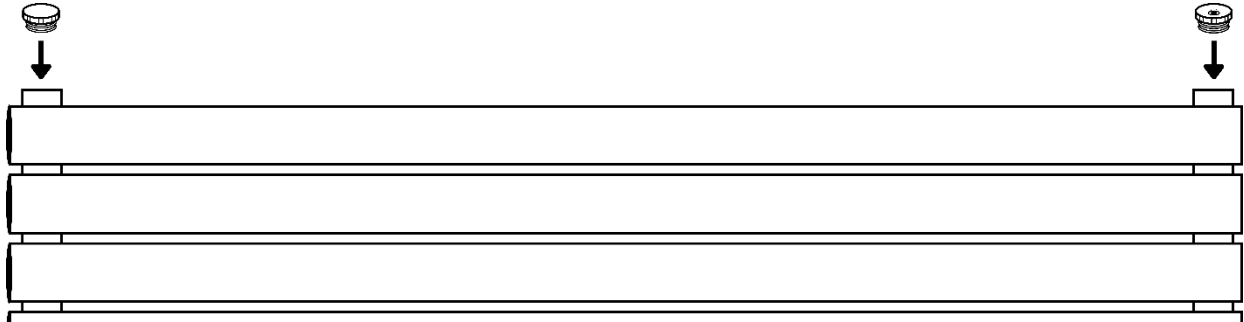

Step 2

(Check Valve Instructions) - If appropriate, apply PTFE tape to valve tails and insert into bottom 2 threads of radiator and tighten with a spanner.

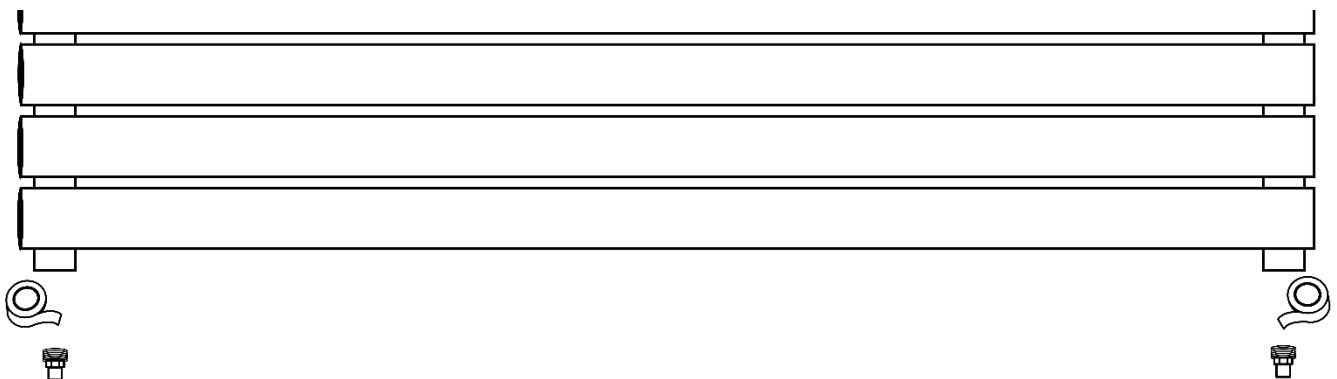

Step 3

Put bolt (H) through bracket (F) and screw onto the back of the radiator at the pre-drilled locations.

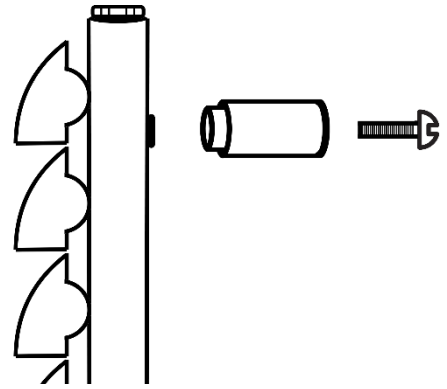

Step 4

Mark the fixing locations with a pencil, 2 near the top of the radiator and 2 near the bottom per the locations of the bracket.

Ensure your markings are level using a spirit level before proceeding.

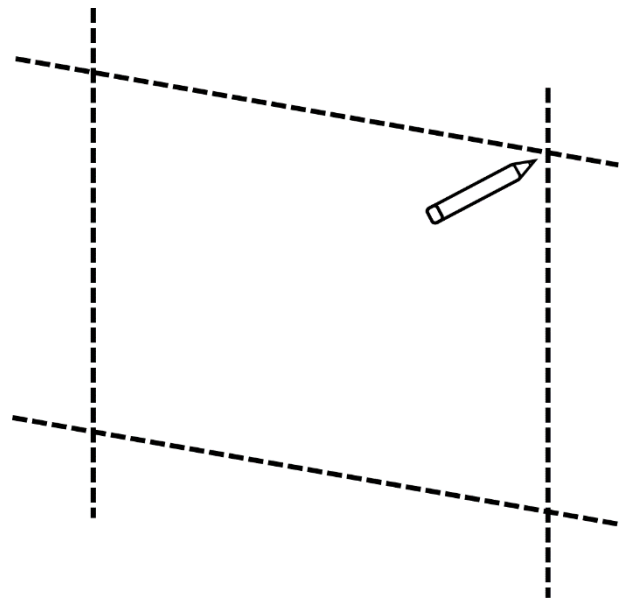
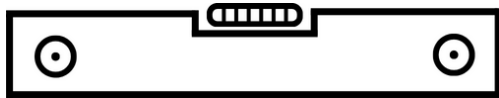

Step 5

Using the 8mm masonry drill bit, drill holes at the marked location and insert masonry wall plugs (C).

(Note: on tiled walls you may need to use a tile drill bit prior to masonry).

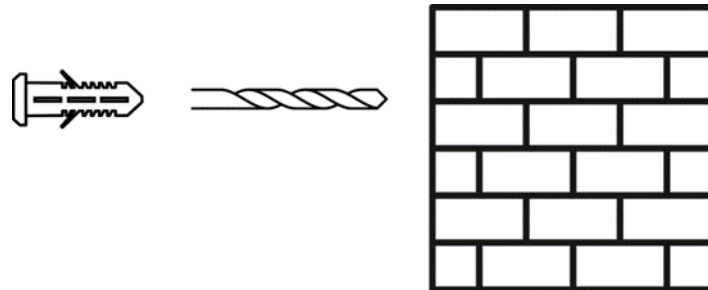

Place the long screw (D) through wall support (E) and tighten into the wall plug.

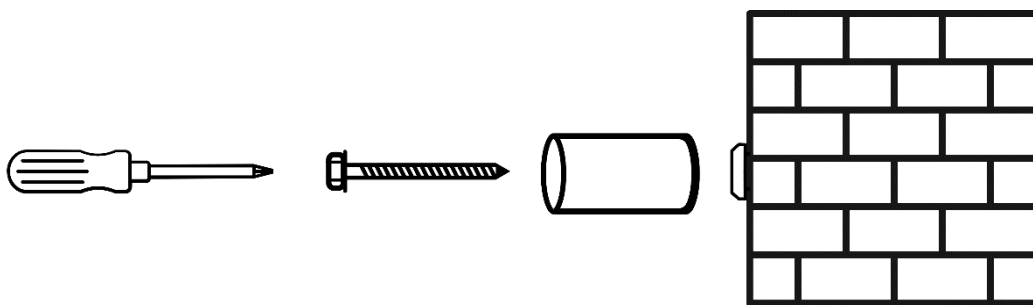

Step 6

Slide the radiator brackets (F) into wall support (E).

Adjust depth as required, then tighten using small screws (G).

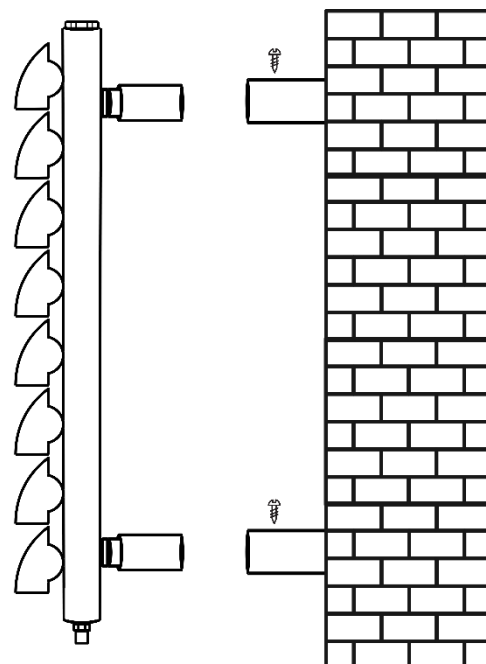

Step 7

You are now ready to run, adjust and connect your piping and valve to the radiator valve tail inserted into the radiator during step 2.

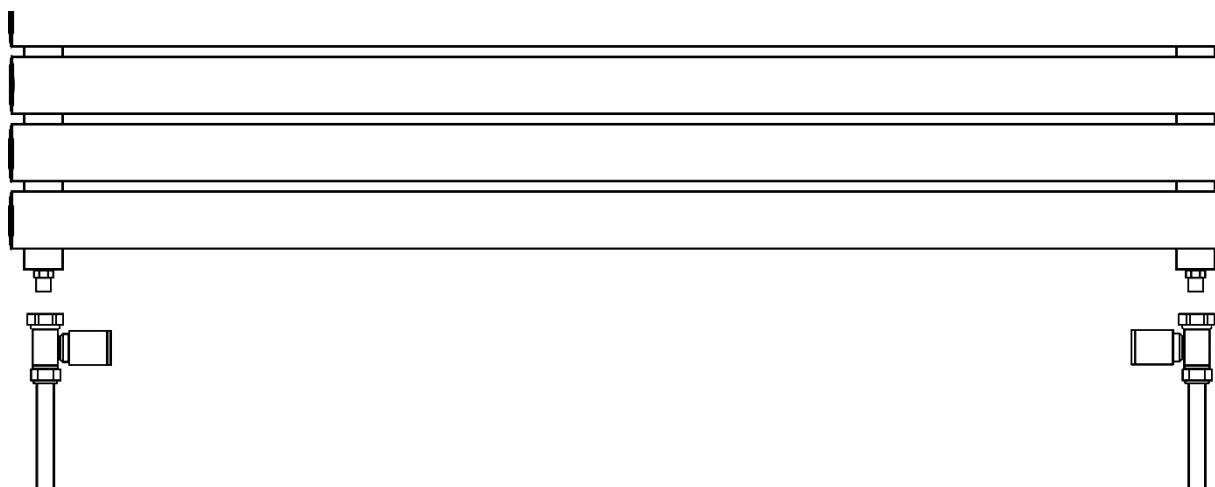

Step 8

Prior to operating the radiator, you may need to flush the system to clear any residue.

Step 9

Prior to operating the radiator, please review the User Manual.

Step 10

When the heating system is turned on for the first time, you may need to bleed the radiator using the air vent installed on the top thread per step 1. You may need to do this several times and if on a pressurised system, you may need to top up the pressure each time the radiator is bled.

Step 11

You may also need to balance the central heating system to account for this radiator.

Step 12

If there are any issues with the radiator, please first consult the User Manual including the troubleshooting section.